

Replacement Parts

TOKINARC®
TOKIN CORPORATION

- Tip
- Nozzle
- Orifice
- Insulation Tube
- Torch Body
- Tip Body
- Inner Tube
- Liner



N/D Tip

- CuCrZr
- Suitable for both Semi-Automatic & Robotic Welding

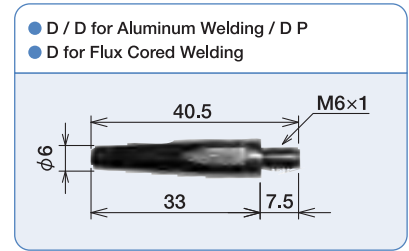
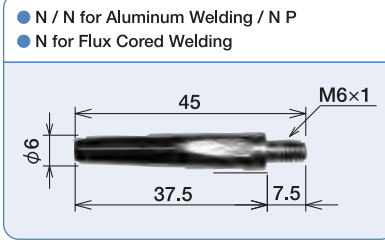

Type	Size	Tokin Part No.	P Part No.	D Part No.
N	0.6	002016	TET00601S TET00624	—
	0.8	002005	TET00841 TET00842	K980C02 K980C23 L7250C01
	0.9	002001	TET00958 TET00942 TET00959	K980C03 K980C24 L7250C02
	1.0	002002	TET01067 TET01055 TET01068	K980C04 K980C25 L7250C03
	1.2	002003	TET01296 TET12005 TET01248 TET01297 TET12003	K980C05 K980C26 L7250C04
	1.4	002017	TET01447 TET01426 TET01448	K980C06 K980C27 L7250C05
	1.6	002004	TET01691 TET01669 TET01692	K980C07 K980C28 L7250C06
	2.0	002020	TET02047	—

Type	Size	Tokin Part No.	P Part No.	D Part No.
D	0.6	023040	TET00625	—
	0.8	023007	TET00843 TET00844	K980B90 K980C29 L7250B01
	0.9	023008	TET00962 TET00944 TET00963	K980B91 K980C30 L7250B02
	1.0	023009	TET01071 TET01057 TET01072	K980B92 K980C31 L7250B03
	1.2	023010	TET12007 TET12008 TET01265 TET12010 TET12011	K980B93 K980C32 L7250B04
	1.4	023041	TET01451 TET01435 TET01452	K980B94 K980C33 L7250B05
	1.6	023011	TET01695 TET01678 TET01696	K980B95 K980C34 L7250B06

Type	Size	Tokin Part No.
N for Flux Cored Welding	1.2	002013
D for Flux Cored Welding	1.2	023042

Type	Size	Tokin Part No.
N for Aluminum Welding	0.8	002023
	1.0	002024
	1.2	002018
	1.6	002019
D for Aluminum Welding	1.2	023043
	1.6	023044

R Tip

- Smaller Bore Size Keeps Stable Arc

Type	Size	Tokin Part No.
N for Robotic Welding	1.2	002014
D for Robotic Welding	1.2	023045

Non-Tapered Bore Tip

- Non-tapered bore prevents from wire/liner scraping when entering to the bore.

● N R / N Non-Tapered Bore

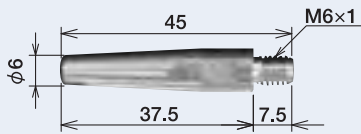

● D R / D Non-Tapered Bore

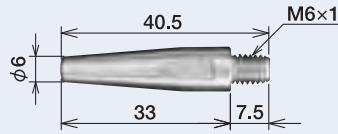

Type	Size	Tokin Part No.
N Non-Tapered Bore	1.0	002054
	1.2	002055
D Non-Tapered Bore	1.0	023054
	1.2	023055

Rocket-Shaped Tip

● N Rocket-Shaped

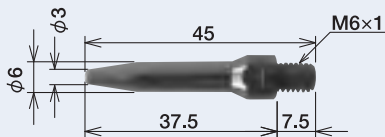

● D Rocket-Shaped

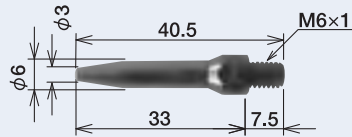

- Useful in Narrow Space
- Use the Tip in Combination with N Narrow Nozzle 73L

Type	Size	Tokin Part No.
N Rocket-Shaped	0.8	002322
	0.9	002323
	1.0	002324
	1.2	002325

Type	Size	Tokin Part No.
D Rocket-Shaped	0.9	023323
	1.0	023324
	1.2	023325

MAG/MIG Tip

● N MAG Tip / N MIG

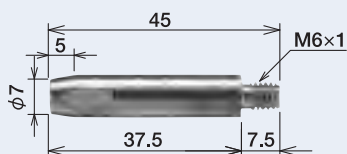

● D MAG Tip / D MIG

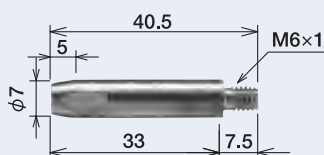

- Good Heat Dissipation Efficiency by Straight Body

Type	Size	Tokin Part No.	P Part No.	D Part No.
N MIG	1.0	002508	TET01046	K980C36
	1.2	002504	TET01253	K980C37
	1.6	002506	TET01666	—
N MAG	1.0	002507	—	U4167H13
	1.2	002503	—	U4167H12
	1.4	002502	—	U4167H11
	1.6	002501	—	U4167H10

Type	Size	Tokin Part No.	P Part No.	D Part No.
D MIG	1.0	023404	—	U2502H03
	1.2	023406	—	K980B20
	1.6	023409	—	K980B21
D MAG	1.0	023403	—	K980B85
	1.2	023405	—	K980B86
	1.4	023407	—	K980B87
	1.6	023408	—	K980B88

Others

● N Long

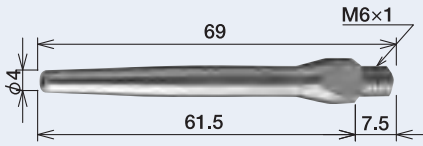

Type	Size	Token Part No.	P Part No.	D Part No.
N Long	0.6	002011	TET00603	—
	0.8	002006	TET00810	U4167H08
	0.9	002007	TET00915	U4167H07
	1.0	002008	TET01013	U4167H06
	1.2	002009	TET01220	U4167H05
	1.4	002012	TET01437	—
	1.6	002010	—	—

● TCC

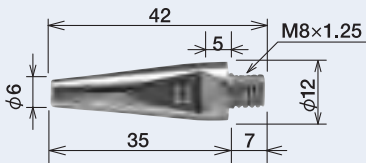

Type	Size	Token Part No.	P Part No.	D Part No.
TCC	0.9	002102	—	K1736D16
	1.0	002101	—	K1736D08
	1.2	002100	—	K1736D06
	1.4	002108	—	K1736D18
	1.6	002107	—	K1736D07

● M8xL30

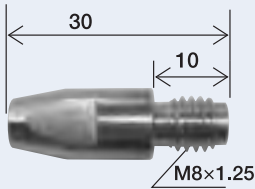

Type	Size	Token Part No.	Part No.
M8L30	1.0	TP2005070-1000	140. 0316
			140. 10. 262. 33
	1.2	TP2005070-1200	140. 0445
			140. 12. 262. 33
	1.4	TP2005070-1400	140. 0536
			140. 14. 262. 33
	1.6	TP2005070-1600	140. 0590
			140. 16. 262. 33

● MAN

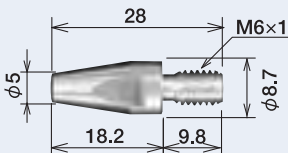

Type	Size	Token Part No.
MAN	0.6	016030
	0.8	016004
	0.9	016005
	1.0	016006
	1.2	016007
	1.4	016031
	1.6	016032

● MT-501G

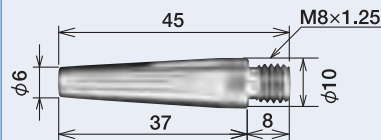

Type	Size	Token Part No.
MT-501G	1.2	025001
	1.4	025003
	1.6	025002
	2.0	025005

Submerged Arc Welding Tip

● Unionmelt

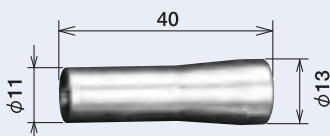

● Unionmelt Tip Body

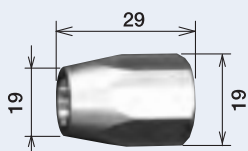

Type	Size	WholeLength	Token Part No.	D Part No.
Unionmelt	1.6	40	023027	—
	2.0	40	023029	—
	2.4	40	023028	U12546-1
	3.2	40	023030	U12546-2
	4.0	40	023032	U12546-3
	4.8	40	023033	U12546-4
	6.0	40	023034	—
	6.4	40	023035	U12546-5

Type	Size	WholeLength	Token Part No.	D Part No.
Unionmelt Tip Body	—	29	023038	U642C07

TEACHING TIP / DUMMY TIP

Dummy Tip

Stainless steel tip with wire extension lengths, used for tasks such as tool calibration.

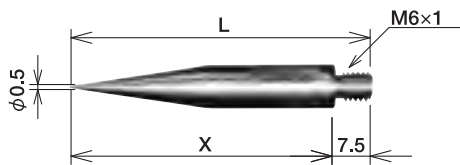

Teaching Tip

Movable tip that are ideal for test operation and other tasks during teaching. Different sizes are available to match the wire protrusion.

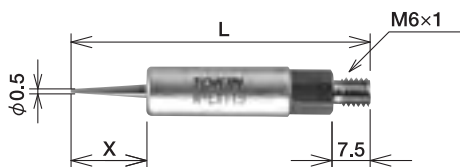

Type	Tokin Part No.	Extension	L	X
N	DT0000N12	12	57	49.5
	DT0000N15	15	60	52.5
	DT0000N20	20	65	57.5
	DT0000N25	25	70	62.5
D	DT0000D12	12	52.5	45
	DT0000D15	15	55.5	48
	DT0000D20	20	60.5	53
	DT0000D25	25	65.5	58

Type	Tokin Part No.	Extension	L	X
N	DTT000N10	10	55	10
	DTT000N12	12	57	12
	DTT000N15	15	60	15
D	DTT000D10	10	50.5	10
	DTT000D12	12	52.5	12

Storage Case

DTT000000

ORIFICE

N S(350A)

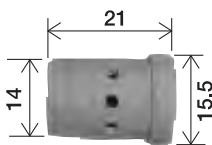

N L(500A)

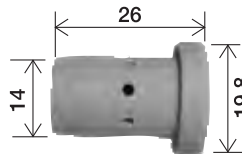

D S(350A)

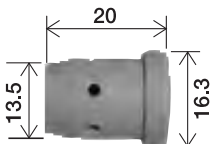

INSULATOR

N S(350A)

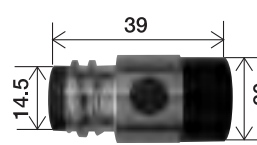

N L(500A)

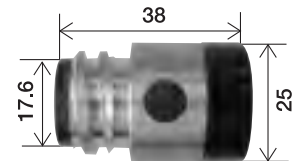

D S(350A)

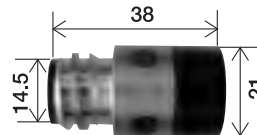

Type	Size	Tokin Part No.	P Part No.	D Part No.
N350A	S	003002	TGR01001	U4167G02
N500A	L	003001	TGR00902	U4173G02
D350A	S	023014	—	U2437H01

Type	Size	Tokin Part No.	P Part No.	D Part No.
N350A	S	004002	TFZ35101	U4167L00
N500A	L	004001	TFZ50107	U4173L00
D350A	S	023015	—	U608T00

NEW β /WX Orifice

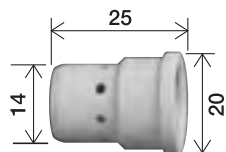

WX Water-Cooled Nozzle Orifice

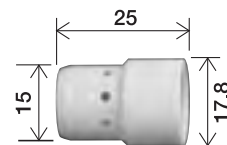

Type	Description	Tokin Part No.	Tokin Torch Model No.
Water-Cooled	NEW β /WX Orifice	034120	WX500/WX451/WX452/ NEW β -500W/ α -500W
Water-Cooled	WX Water-Cooled Nozzle Orifice	034121	WX500/WX451/WX452/ NEW β -500W/ α -500W

WAVED WASHER

Waved Washer S



Waved Washer L

Type	Size	Tokin Part No.	P Part No.	D Part No.
350A	S	255406	—	—
500A	L	255407	—	—

NOZZLE

200A Insulation Nozzle

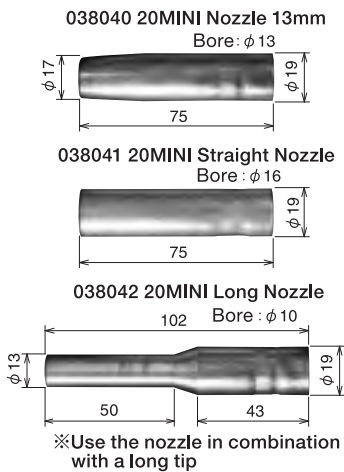

D 350A Nozzle

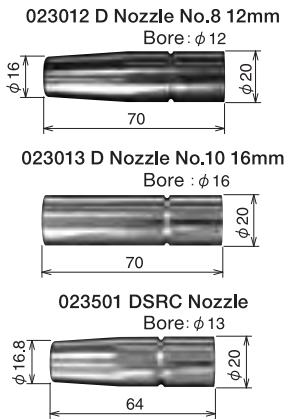

N 350A Nozzle

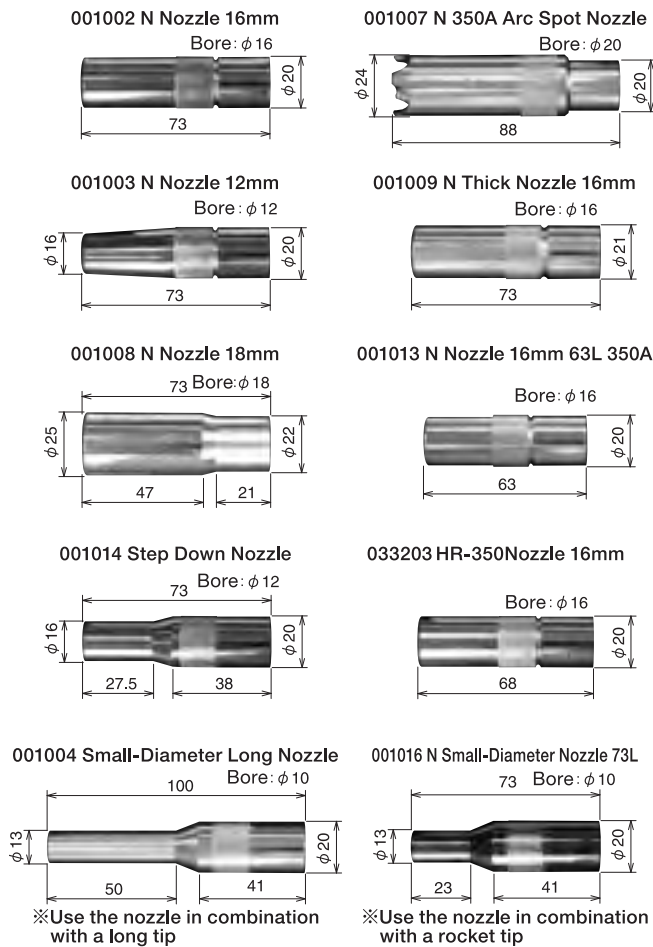

N 500A Nozzle

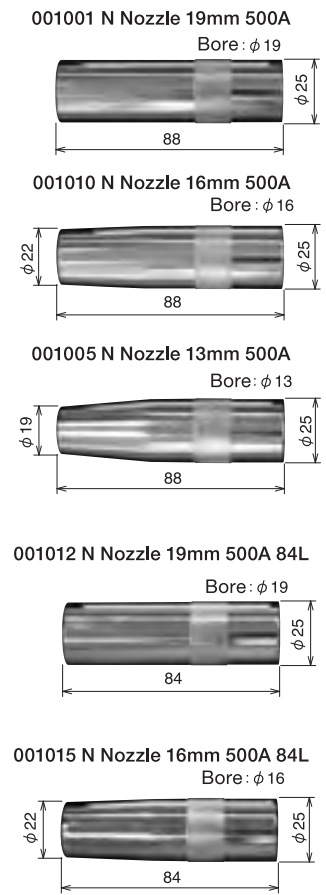

Nozzle		Size			Part No.		
Type	Description	ID	OD	Length	Tokin	P Part No.	D Part No.
180A 200A Insulated	CSL-18,20 Nozzle 13mm	13	17	75	038040	TGN01208	U4186L00 U5342N00
	CSL-18,20 Straight Nozzle	16	19	75	038041	TGN01506	U4186P00 U5342P00
	CSL-18, 20 Long Nozzle	10	13	102	038042	TGN01026	U4186R00
N 350A	N Nozzle 16mm	16	20	73	001002	TGN00043	U4167G01
	N Nozzle 12mm	12	16	73	001003	TGN00044	U4167H01
	N Nozzle 18mm	18	25	73	001008	TGN00111	U4167H02
	Step Down Nozzle	12	16	73	001014	TGN00105	-
	N Small-Diameter Long Nozzle	10	13	100	001004	TGN01001	U4167H04
	N 350A Arc Spot Nozzle	20	24	88	001007	TGN02001	U4167H03
	N Thick Nozzle	16	21	73	001009	TGN00038	U4167H16
	N Nozzle 16mm 63L 350A	16	21	63	001013	TGN01663	-
	HR-350Nozzle 16mm/ N Nozzle 16mm 68L	16	20	68	033203	-	-
N Small-Diameter Nozzle 73L	10	13	73	001016	-	-	
D 350A	D Nozzle No.8 12mm	12	16	70	023012	-	U608N01
	D Nozzle No.10 16mm	16	20	70	023013	-	U608N02 U2437J04
	DSRC Nozzle	13	16.8	64	023501	-	L6380F03
N 500A	N Nozzle 19mm 500A	19	25	88	001001	TGN00055	U4173G01
	N Nozzle 16mm 500A	16	22	88	001010	TGN00057	U4173H01
	N Nozzle 13mm 500A	13	19	88	001005	TGN00064	-
	N Nozzle 19mm 500A 84L	19	25	84	001012	TGN00050 TGN00056	-
	N Nozzle 16mm 500A 84L	16	22	84	001015	TGN00058 TGN00065	-

OTHER NOZZLE

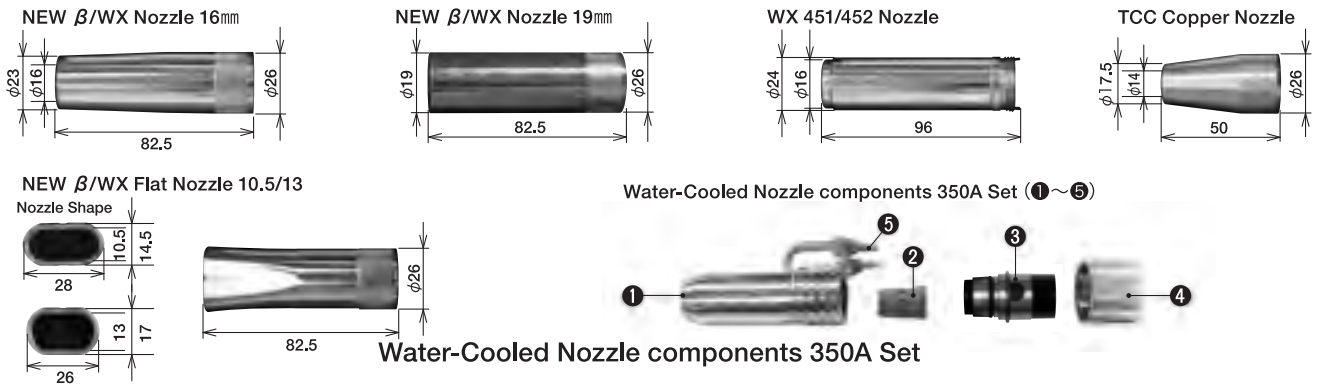

Others Nozzle		Size			Tokin Part No.	Tokin Torch Model No.
Type	Description	ID	OD	Whole Length		
500A	NEW β/WX Nozzle 16mm	16	23	82.5	034115	WX500 / 451 / 452 / NEW β-500W / α-500W
500A	NEW β/WX Nozzle 19mm	19	26	82.5	034116	WX500 / 451 / 452 / NEW β-500W / α-500W
500A	New β/WX Flat Nozzle 10.5	10.5x24	26	82.5	034200	WX500 / 451 / 452 / NEW β-500W / α-500W
500A	New β/WX Flat Nozzle 13	13x22	26	82.5	034201	WX500 / 451 / 452 / NEW β-500W / α-500W
500A	WX 451/452 Nozzle	16	24	82.5	061450	WX500 / 451 / 452 / NEW β-500W / α-500W
350A	TCC Nozzle (Cu)	14	17.5	50	023121	MNF
350A	Water-Cooled Nozzle components 350A Set	16	21	73	WN0402252	350A Air-Cooled Torch
	For Water-Cooled Nozzle specifications, following parts needed. ①350A Water-Cooled Nozzle (Nut Type) ②N Orifice S ③WX Water-Cooled Insulator S ④Water-Cooled Nozzle Nut ⑤Micro Coupler Plug ⑥Water-Cooled Nozzle Water Hose					

CARBON NOZZLE

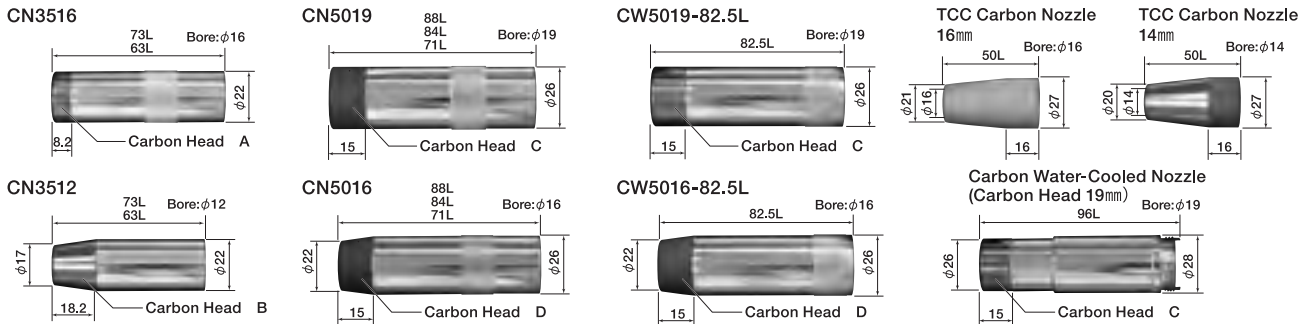

Carbon Nozzle			Size			Part No.
Type	Description	Head	ID	OD	Whole Length	Tokin
350A	Carbon Nozzle Assy CN3516-73	A	16	22	73	CN351673
	Carbon Nozzle Assy CN3516-63	A	16	22	63	CN351663
	Carbon Nozzle Assy CN3512-73	B	12	17	73	CN351273
	Carbon Nozzle Assy CN3512-63	B	12	17	63	CN351263
500A	Carbon Nozzle Assy CN5019-88	C	19	26	88	CN501988
	Carbon Nozzle Assy CN5019-84	C	19	26	84	CN501984
	Carbon Nozzle Assy CN5019-71	C	19	26	71	CN501971
	Carbon Nozzle Assy CN5016-88	D	16	22	88	CN501688
	Carbon Nozzle Assy CN5016-84	D	16	22	84	CN501684
	Carbon Nozzle Assy CN5016-71	D	16	22	71	CN501671
	Carbon Nozzle Assy CW5019-82.5	C	19	26	82.5	CW5019825
	Carbon Nozzle Assy CW5016-82.5	D	16	22	82.5	CW5016825
350A	TCC Carbon Nozzle 16mm	-	16	22	50	023120
	TCC Carbon Nozzle 14mm	-	14	17.5	50	023124
	Carbon Water-Cooled Nozzle (Carbon Head 19mm)	C	19	26	96	NX0811260

TORCH BODY

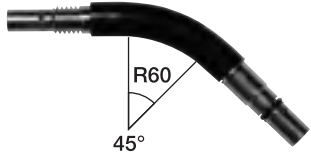
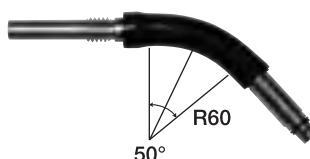
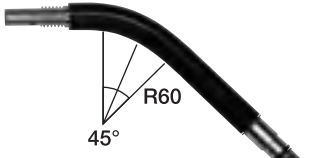
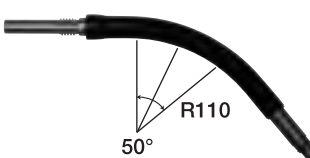
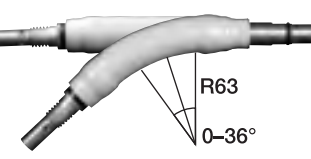
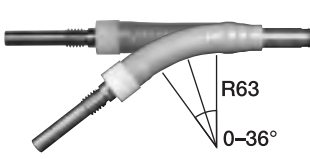
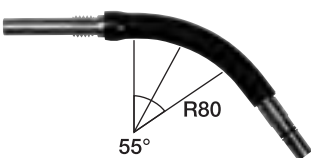
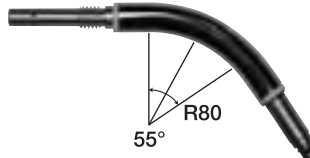
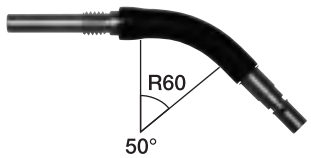
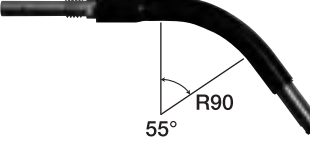
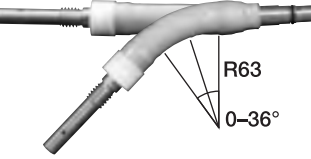
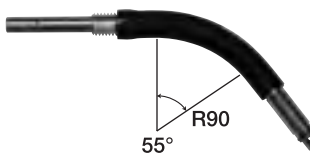
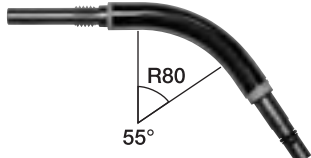
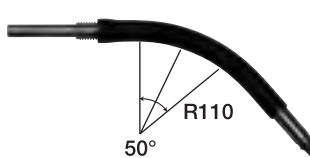
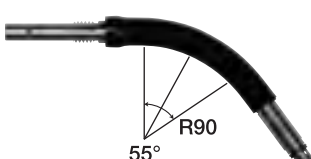
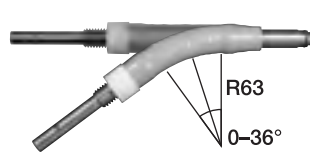
	Appearance	Tokin Part No.		Appearance	Tokin Part No.	
180A ∩ 200A		Tokin Torch Model No. CSL-18 CSL-20	Torch Body 038054 (Integrated) Tip Body		Tokin Torch Model No. CSH-35K	
					Torch Body (w/Tip Body) 038003 Torch Body (w/o Tip Body) 038004	
200A		Tokin Torch Model No. CSL-20L	Torch Body 038056 (Integrated) Tip Body		Tokin Torch Model No. CSH-35L CSH-45L	
					Torch Body (w/Tip Body) 050303 Torch Body (w/o Tip Body) 050302	
350A ∩ 450A		Tokin Torch Model No. CSL-20F	Torch Body 038060 (Integrated) Tip Body		Tokin Torch Model No. CSH-35F CSH-45F	
					Torch Body (w/Tip Body) 036023 Torch Body (w/o Tip Body) 036024	
350A ∩ 450A		Tokin Torch Model No. CSL-35	Torch Body (w/Tip Body) 020305 Torch Body (w/o Tip Body) 020306		Tokin Torch Model No. CSH-35G	
					Torch Body (w/Tip Body) 036050 Torch Body (w/o Tip Body) 036051	
		Tokin Torch Model No. CSL-35K	Torch Body (w/Tip Body) 038057 Torch Body (w/o Tip Body) 038070		Tokin Torch Model No. CSH-35V CSH-45V	
					Torch Body (w/Tip Body) 036101 Torch Body (w/o Tip Body) 036102	
		Tokin Torch Model No. CSL-35F	Torch Body (w/Tip Body) 020204 Torch Body (w/o Tip Body) 020205		Tokin Torch Model No. CSH-50	
					Torch Body (w/Tip Body) 036020 Torch Body (w/o Tip Body) 036022	
		Tokin Torch Model No. CSL-35G	Torch Body (w/Tip Body) 020201 Torch Body (w/o Tip Body) 020202		Tokin Torch Model No. CSH-50L	
					Torch Body (w/Tip Body) 050301 Torch Body (w/o Tip Body) 050302	
		Tokin Torch Model No. CSH-35 CSH-45	Torch Body (w/o Tip Body) 036022 Torch Body (w/Tip Body) 036021		Tokin Torch Model No. CSH-50F	
					Torch Body (w/Tip Body) 036027 Torch Body (w/o Tip Body) 036024	
	500A					

TIP BODY

Current	Appearance	Description (Tokin Part No.)	Tokin Torch Model No.
350A		CS Tip Body A 036001	CSL-35 / 35F / 35K / 35G / CP-35 / CSH-35 / 35F / 35L / 35K / 35G / 45 / 45F / 45L
500A		CS Tip Body B 036001	CSH-50 / 50F / 50L
		CS Tip Body D 036001	





INNER TUBE

Appearance	Tokin Part No.	Inner Tube Length	Tokin Torch Model No.
	038053	130	CSL-18 CSL-20
	038072	179	CSL-20L
	038061	210	CSL-20F
	020210	200	CSL-35 CSL-35K CSL-35G
	020212	210	CSL-35F
	036014	130	CP-35
	036011	210	CSH-35K CSH-35 CSH-45 CSH-50
	050310	260	CSH-35L CSH-45L CSH-50L
	036350	225	CSH-35F CSH-45F CSH-50F

LINER

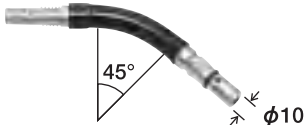
Current	Appearance	Tokin Part No.	Wire Size	Torch Cable Length	Liner Length	Tokin Torch Model No.
180A		037001	0.6	3.0m	3400	CSL-18 / CSL-18L / CSL-18F
200A		037002	0.8 - 0.9	3.0m	3200	CSL-20 / CSL-20L / CSL-20F / CSL-35 / CSL-35K / CSL-35L / CSL-35F / CSL-35G / CSH-35 / CSH-35K / CSH-35V / CSH-35L / CSH-35G / CSH-35F / CSH-35T
200A 350A		037003	1.0 - 1.2	3.0m	3200	
		037004		4.0m	4200	
		037046	1.2	4.5m	4700	CSL-35 / CSL-35K / CSL-35L / CSL-35F / CSL-35G / CSH-35 / CSH-35K / CSH-35V / CSH-35L / CSH-35G / CSH-35F / CSH-35T
		037005		5.0m	5200	
350A		037006		6.0m	6200	
		037007	1.4	3.0m	3200	CSH-35 / CSH-35K / CSH-35V / CSH-35L / CSH-35G / CSH-35F / CSH-35T
		037008		4.0m	4200	
		037047		4.5m	4700	
	037009	5.0m		5200		
037050	6.0m	6200				
450A 500A	036044	1.2 - 1.6	3.0m	3200	CSH-45 / CSH-45K / CSH-45V / CSH-45L / CSH-45F / CSH-50 / CSH-50L / CSH-50F	
	036043		4.0m	4200		
	036047		4.5m	4700		
	036042		5.0m	5200		
350A	0431030	ID 2.0	3.0m	3200	CSH-35	
	0431040		4.0m	4200		
450A 500A	0441030	ID 2.5	3.0m	3200	CSH-45 CSH-50	
	0441040		4.0m	4200		

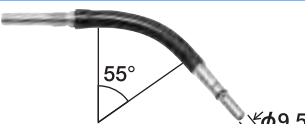
OTHER TORCH BODY

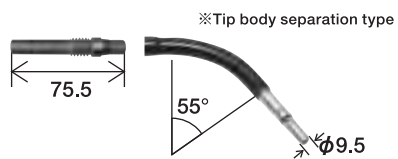

Current	Appearance	Tokin Part No.	P Part No.	P Model No.
180A ∩ 200A		022010	TCU20111	YT-18CS YT-20CS YT-18DS YT-20DS YT-18ES YT-20ES
350A Low Duty Cycle		022011	TCU35056	YT-35CE YT-35DE YT-35EE
350A High Duty Cycle		022012	TCU35022	YT-35CS YT-35CH4 YT-35DS YT-35ES
500A		022014	TCX00006	YT-50CS YT-50CSG YT-50DS YT-50DSG3 YT-50CSA3 YT-50DSA3
350A Flexible		022016	TCU35001	YT-35CF YT-35DF
350A Separation Type (High Duty Cycle)		022021 (Torch Body Only) 022031 (Tip Body) 022017 Torch Body (w/Tip Body)	TCU35002 (Torch Body) TEB35116 (Tip Body)	YT-35CS YT-35CH4 YT-35DS YT-35ES

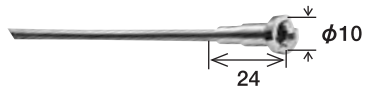
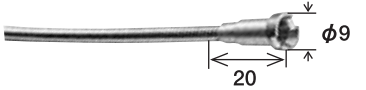
INNER TUBE



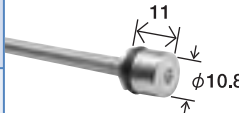

Current	Appearance	Tokin Part No.	Length	P Part No.	P Model No.		
200A		022061	113	TGT00607 TGT20108	YT-20CS3 YT-20DS3		
350A Low Duty Cycle		022063	213	TGT00608 TGT00609 TGT00036 TGT00034	YT-35CE / YT-35DE / YT-35EE / YT-20MD1 / YT-20-MF1 / YT-35CS / YT-35CSG4 / YT-35DS / YT-35ES / YT-35ESG4 / YT-35CH4 / YT-35CSA3 / YT-35DSA3		
500A				022064	238	TGT00033	YT-50CS / YT-50DS / YT-50CSG / YT-50DSG3 / YT-50CSA3 / YT-35DSA3
350A Flexible				022065	210	TGT00615 TGT01213	YT-35CF YT-35DF

REPLACEMENT PARTS for P-Type

LINER

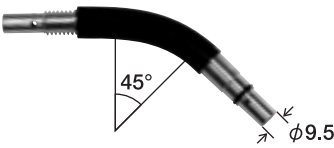
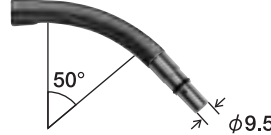
Current	Appearance	Tokin Part No.	Wire Size	Torch Cable Length	Liner Length	P Part No.	P Model No.
200A } 350A		022101	0.9~1.2	3m	3200	TDT00261 TDT00066	YT-20CS / YT-20CF / YT-35CE / YT-35DE / YT-20DS / YT-20DF / YT-20MD1 / YT-20MF1 / YT-35CS
200A } 350A		022102	0.9~1.2	4.5m	4700	TDT00264 TDT00067	YT-35CEM / YT-35DEM
350A		022103	0.9~1.2	3m	3200	TDT00262 TDT00057	YT-35CS / YT-35DS / YT-35CF / YT-35DF / YT-35CSG / YT-35DSG / YT-35CH4 / YT-30ME1 / YT-35CSA3 / YT-35DSA3
350A		022104	0.9~1.2	4.5m	4700	TDT00265 TDT00058	YT-35CSM / YT-35DSM / YT-35CFM / YT-35DFM / YT-35CHM4
350A		022105	0.9~1.2	6m	6200	TDT00266 TDT00059	YT-35CSL / YT-35DSL / YT-35CFL / YT-35DFL / YT-35CHL4
500A		022106	1.2~1.6	3m	3200	TDT00263 TDT00054	YT-50CS / YT-50DS / YT-50CSG3 / YT-50DSG3 / YT-50CSA3 / YT-50DSA3
500A		022107	1.2~1.6	4.5m	4700	TDT00267 TDT00055	YT-50CEM / YT-50DEM / YT-50CSM / YT-50DSM
500A		022108	1.2~1.6	6m	6200	TDT00268 TDT00056	YT-50CSL / 50DSL / YT-50CEL / YT-50DEL

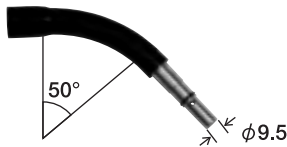
TORCH BODY FOR WTCX SERIES/WT SERIES

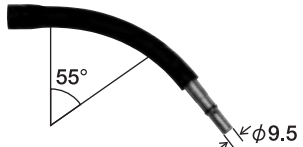
Current	Appearance	Tokin Part No.	D Part No.	D Model No.
180A } 200A		023487 (Integrated Tip Body)	U5020C00 U4186B00	WT1800 WT2000 WTCX1800 WTCX2000
350A (Low Duty Cycle)		0234890 Torch Body Only	U5344B00	WT3500 WTCX-3504
350A Flexible Type (Low Duty Cycle)		0234180 Torch Body Only	U5339K00	WT3500F WTCFX-3504
350A (High Duty Cycle)		0234270 Torch Body Only	U5347B00 U4167B00	WT3510 WTCX-3503
350A Flexible Type (High Duty Cycle)	Flexible Type 	0234290 Torch Body Only	U5339L00 K4945B00	WT3510F WTCFX-3503
450A Flexible Type	Flexible Type 	0234290 Torch Body Only	U5339L00 K4945B00	WT3520F WTCFX-4301
500A		0234850 Torch Body Only	U5353B00 U4173B00	WT5000 WTCX-5002

Torch Body ONLY, no Tip Body included.

TIP BODY FOR WTCX SERIES/WT SERIES

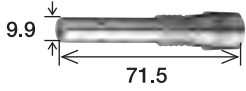
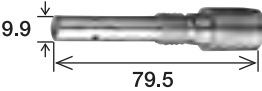
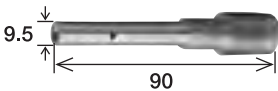
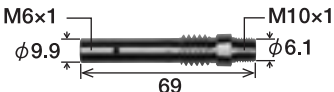
Current	Appearance	Tokin Part No.	D Part No.	D Model No.
350A		023461	U4170G03	WT3500 WTCX-3504
350A 450A		023462	U4167G03	WT3510 WTCX-3503
500A		023463	U4173G03 U4173G21	WT5000 WTCX-5002
Flexible		036001	K4945C01	WT3500F WT3510F WT3520F WTCFX-3504 WTCFX-3503 WTCFX-4301



REPLACEMENT PARTS for D-Type

LINER FOR WTCX SERIES/WT SERIES

Current	Appearance	Tokin Part No.	Wire Size	Torch Cable Length	Liner Length	D Part No.	D Model No.
200A 350A		023443	0.9~1.2	3m	3400	U4186G01 U4170H02	WT1800 WT2000 WT3500 WT3510
		023471	0.9~1.2	4.5m	4900	U4535G01	WTC(M)X-2001 WTC(M,L)X-3504 WTC(M,L)X-3503
		023445	0.9~1.2	6m	6400	U4172H01	
500A		023446	1.2~1.6	3m	3400	U4173G004	WT5000 WTC(M,L)X-5002
		023472	1.2~1.6	4.5m	4900	U4537G01	
		023448	1.2~1.6	6m	6400	U4175G04	

REPLACEMENT PARTS for D-Type

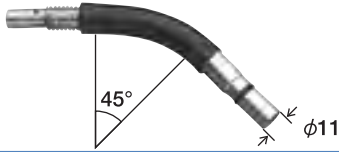
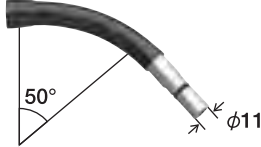
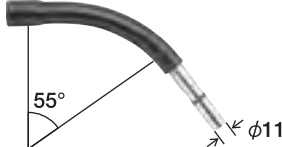
TORCH BODY FOR WTC SERIES

Current	Appearance	Token Part No.	D Part No.	D Model No.
200A		023421	U2773B00	WTC-2001
350A		0234220	U3286B00	WTC-3504
350A		0234230	U2695B00	WTC-3503
500A		0234240	U2774B00	WTC-5002
350A	Flexible Type 	0234250	K1885B00	WTCF-3503

TIP BODY FOR WTC SERIES

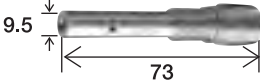
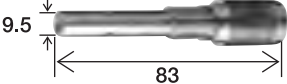
Current	Appearance	Token Part No.	D Part No.	D Model No.
350A		023466	U3286J01	WTC-3504
350A 500A		023467	U2437H07	WTC-3503 WTC-5002

LINER FOR WTC SERIES

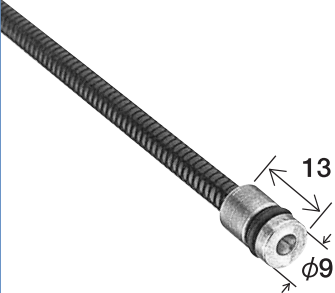
Current	Appearance	Token Part No.	Wire Size	Torch Cable Length	Liner Length	D Part No.	D Model No.
200A 350A		023435	0.9~1.2	3m	3400	U2773E01 U2627M01	WTC(M)-2001 WTC(M,L)-3504 WTC(M,L)-3503 WTC(M,L)F-3503
		023436	0.9~1.2	4m	4400	U2945E01 U2946J01	
		023437	0.9~1.2	6m	6400	U2626M01	
500A		023438	1.2~1.6	3m	3400	U2774E02	WTC(M,L)-5002
		023439	1.2~1.6	4m	4400	U2954E01	
		023440	1.2~1.6	6m	6400	U2626M02	

REPLACEMENT PARTS for O-Type

TORCH BODY

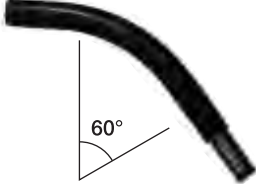
Current	Appearance	Tokin Part No.	O Part No.	O Model No.
350A		024025	060-430	OMT-3
500A		024027	060-650	OMT-5

TIP BODY

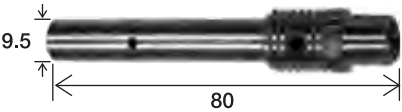
Current	Appearance	Tokin Part No.	O Part No.	O Model No.
350A		024014	050-035	OMT-3
500A		024015	050-055	OMT-5

LINER

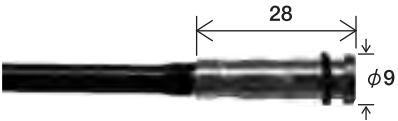
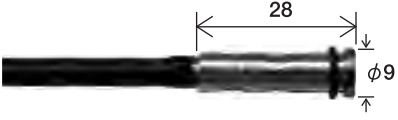
Current	Appearance	Tokin Part No.	Wire Size	Torch Cable Length	Liner Length	O Part No.	O Model No.
350A		024034	0.9~1.2	3m	3400	070-332	OMT-3
		024035	0.9~1.2	4.5m	4900	070-432	
		024036	0.9~1.2	6m	6400	070-632	
500A		024038	1.2~1.6	3m	3400	070-335	OMT-5
		024039	1.2~1.6	4.5m	4900	070-435	
		024040	1.2~1.6	6m	6400	070-635	



Product Catalogue



Air-Cooled
 Robotic Torches



Semi-Automatic Torches



TIG Welding Torches



Water-Cooled
 Robotic Torches



Robotic Peripherals

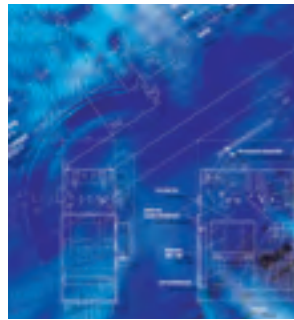

Fume Extractors

**Please contact us by FAX or E-mail for catalogues that interest you.
 You can also download them from our website.**

TOKIN CORPORATION

1509 Okubo-cho, Nishi-ku, Hamamatsu-shi, Shizuoka Japan 432-8006
 TEL : +81-53-485-5252, FAX : +81-53-485-5680
 E-mail trading@tokinarc.co.jp URL <http://www.tokinarc.co.jp>

North, Central, South Americas

TOKIN AMERICA CORPORATION

9844 Windisch Rd West Chester, OH USA 45069
 TEL : +1-513-644-9743, FAX : +1-513-644-9749
 E-mail info@tokinamerica.com URL <http://www.tokinamerica.com>

China

SUZHOU TOKIN MACHINE & METAL CORPORATION

No.107 Dong Cang North Road, Economic Development Zone, Tai cang city, Jiang su, China,
 TEL : +86-512-53569095, FAX : +86-512-53577726
 E-mail sales@tokinarc.com.cn URL <http://www.tokinarc.com>

For more information, contact us at



Part specifications, dimensions and design may be changed without prior notice for the purpose of part improvement. The product color shown here is a printed image and the actual color might vary somewhat.



This catalog was printed on recycled paper with SOY ink.

2017.6.500